



0962CH12

## CHAPTER 12

### HERON'S FORMULA

#### 12.1 Introduction

You have studied in earlier classes about figures of different shapes such as squares, rectangles, triangles and quadrilaterals. You have also calculated perimeters and the areas of some of these figures like rectangle, square etc. For instance, you can find the area and the perimeter of the floor of your classroom.

Let us take a walk around the floor along its sides once; the distance we walk is its perimeter. The size of the floor of the room is its area.

So, if your classroom is rectangular with length 10 m and width 8 m, its perimeter would be  $2(10\text{ m} + 8\text{ m}) = 36\text{ m}$  and its area would be  $10\text{ m} \times 8\text{ m}$ , i.e.,  $80\text{ m}^2$ .

Unit of measurement for length or breadth is taken as metre (m) or centimetre (cm) etc.

Unit of measurement for area of any plane figure is taken as square metre ( $\text{m}^2$ ) or square centimetre ( $\text{cm}^2$ ) etc.

Suppose that you are sitting in a triangular garden. How would you find its area? From Chapter 9 and from your earlier classes, you know that:

$$\text{Area of a triangle} = \frac{1}{2} \times \text{base} \times \text{height} \quad (\text{I})$$

We see that when the triangle is **right angled**, we can directly apply the formula by using two sides containing the right angle as base and height. For example, suppose that the sides of a right triangle ABC are 5 cm, 12 cm and 13 cm; we take base as 12 cm and height as 5 cm (see Fig. 12.1). Then the

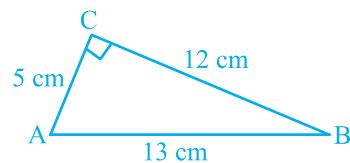

Fig. 12.1

area of  $\Delta ABC$  is given by

$$\frac{1}{2} \times \text{base} \times \text{height} = \frac{1}{2} \times 12 \times 5 \text{ cm}^2, \text{ i.e., } 30 \text{ cm}^2$$

Note that we could also take 5 cm as the base and 12 cm as height.

Now suppose we want to find the area of an **equilateral triangle** PQR with side 10cm (see Fig. 12.2). To find its area we need its height. Can you find the height of this triangle?

Let us recall how we find its height when we know its sides. This is possible in an equilateral triangle. Take the mid-point of QR as M and join it to P. We know that PMQ is a right triangle. Therefore, by using Pythagoras Theorem, we can find the length PM as shown below:

$$PQ^2 = PM^2 + QM^2$$

$$\text{i.e., } (10)^2 = PM^2 + (5)^2, \text{ since } QM = MR.$$

Therefore, we have  $PM^2 = 75$

$$\text{i.e., } PM = \sqrt{75} \text{ cm} = 5\sqrt{3} \text{ cm}.$$

$$\text{Then area of } \Delta PQR = \frac{1}{2} \times \text{base} \times \text{height} = \frac{1}{2} \times 10 \times 5\sqrt{3} \text{ cm}^2 = 25\sqrt{3} \text{ cm}^2.$$

Let us see now whether we can calculate the area of an **isosceles triangle** also with the help of this formula. For example, we take a triangle XYZ with two equal sides XY and XZ as 5 cm each and unequal side YZ as 8 cm (see Fig. 12.3).

In this case also, we want to know the height of the triangle. So, from X we draw a perpendicular XP to side YZ. You can see that this perpendicular XP divides the base YZ of the triangle in two equal parts.

$$\text{Therefore, } YP = PZ = \frac{1}{2} YZ = 4 \text{ cm}$$

Then, by using Pythagoras theorem, we get

$$\begin{aligned} XP^2 &= XY^2 - YP^2 \\ &= 5^2 - 4^2 = 25 - 16 = 9 \end{aligned}$$

$$\text{So, } XP = 3 \text{ cm}$$

$$\begin{aligned} \text{Now, area of } \Delta XYZ &= \frac{1}{2} \times \text{base } YZ \times \text{height } XP \\ &= \frac{1}{2} \times 8 \times 3 \text{ cm}^2 = 12 \text{ cm}^2. \end{aligned}$$

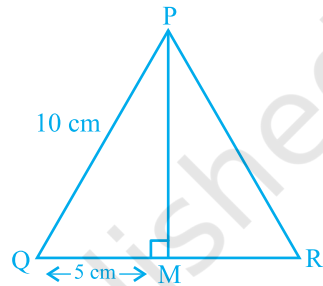

Fig. 12.2

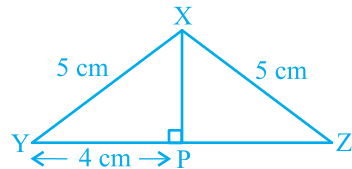

Fig. 12.3

Now suppose that we know the lengths of the sides of a scalene triangle and not the height. Can you still find its area? For instance, you have a triangular park whose sides are 40 m, 32 m, and 24 m. How will you calculate its area? Definitely if you want to apply the formula, you will have to calculate its height. But we do not have a clue to calculate the height. Try doing so. If you are not able to get it, then go to the next section.

## 12.2 Area of a Triangle — by Heron's Formula

Heron was born in about 10AD possibly in Alexandria in Egypt. He worked in applied mathematics. His works on mathematical and physical subjects are so numerous and varied that he is considered to be an encyclopedic writer in these fields. His geometrical works deal largely with problems on mensuration written in three books. Book I deals with the area of squares, rectangles, triangles, trapezoids (trapezia), various other specialised quadrilaterals, the regular polygons, circles, surfaces of cylinders, cones, spheres etc. In this book, Heron has derived the famous formula for the area of a triangle in terms of its three sides.



Heron (10 C.E. – 75 C.E.)

Fig. 12.4

The formula given by Heron about the area of a triangle, is also known as *Heron's formula*. It is stated as:

$$\text{Area of a triangle} = \sqrt{s(s-a)(s-b)(s-c)} \quad (\text{II})$$

where  $a$ ,  $b$  and  $c$  are the sides of the triangle, and  $s =$  semi-perimeter, i.e., half the

$$\text{perimeter of the triangle} = \frac{a + b + c}{2},$$

This formula is helpful where it is not possible to find the height of the triangle easily. Let us apply it to calculate the area of the triangular park ABC, mentioned above (see Fig. 12.5).

Let us take  $a = 40$  m,  $b = 24$  m,  $c = 32$  m,

$$\text{so that we have } s = \frac{40 + 24 + 32}{2} \text{ m} = 48 \text{ m.}$$

$$s - a = (48 - 40) \text{ m} = 8 \text{ m},$$

$$s - b = (48 - 24) \text{ m} = 24 \text{ m},$$

$$s - c = (48 - 32) \text{ m} = 16 \text{ m}.$$

Therefore, area of the park ABC

$$\begin{aligned} &= \sqrt{s(s-a)(s-b)(s-c)} \\ &= \sqrt{48 \times 8 \times 24 \times 16} \text{ m}^2 = 384 \text{ m}^2 \end{aligned}$$

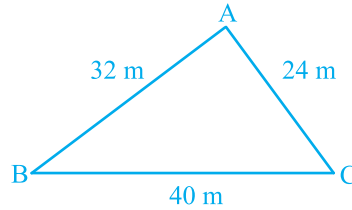

Fig. 12.5

We see that  $32^2 + 24^2 = 1024 + 576 = 1600 = 40^2$ . Therefore, the sides of the park make a right triangle. The largest side, i.e., BC which is 40 m will be the hypotenuse and the angle between the sides AB and AC will be  $90^\circ$ .

By using Formula I, we can check that the area of the park is  $\frac{1}{2} \times 32 \times 24 \text{ m}^2 = 384 \text{ m}^2$ .

We find that the area we have got is the same as we found by using Heron's formula.

Now using Heron's formula, you verify this fact by finding the areas of other triangles discussed earlier viz.,

- (i) equilateral triangle with side 10 cm.
- (ii) isosceles triangle with unequal side as 8 cm and each equal side as 5 cm.

You will see that

$$\text{For (i), we have } s = \frac{10 + 10 + 10}{2} \text{ cm} = 15 \text{ cm}.$$

$$\begin{aligned} \text{Area of triangle} &= \sqrt{15(15-10)(15-10)(15-10)} \text{ cm}^2 \\ &= \sqrt{15 \times 5 \times 5 \times 5} \text{ cm}^2 = 25\sqrt{3} \text{ cm}^2 \end{aligned}$$

$$\text{For (ii), we have } s = \frac{8 + 5 + 5}{2} \text{ cm} = 9 \text{ cm}$$

$$\text{Area of triangle} = \sqrt{9(9-8)(9-5)(9-5)} \text{ cm}^2 = \sqrt{9 \times 1 \times 4 \times 4} \text{ cm}^2 = 12 \text{ cm}^2.$$

Let us now solve some more examples:

**Example 1 :** Find the area of a triangle, two sides of which are 8 cm and 11 cm and the perimeter is 32 cm (see Fig. 12.6).

**Solution :** Here we have perimeter of the triangle = 32 cm,  $a = 8$  cm and  $b = 11$  cm.

Third side  $c = 32$  cm  $- (8 + 11)$  cm = 13 cm

So,  $2s = 32$ , i.e.,  $s = 16$  cm,

$s - a = (16 - 8)$  cm = 8 cm,

$s - b = (16 - 11)$  cm = 5 cm,

$s - c = (16 - 13)$  cm = 3 cm.

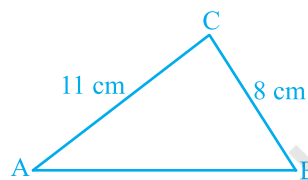

Fig. 12.6

$$\begin{aligned} \text{Therefore, area of the triangle} &= \sqrt{s(s-a)(s-b)(s-c)} \\ &= \sqrt{16 \times 8 \times 5 \times 3} \text{ cm}^2 = 8\sqrt{30} \text{ cm}^2 \end{aligned}$$

**Example 2 :** A triangular park ABC has sides 120m, 80m and 50m (see Fig. 12.7). A gardener *Dhania* has to put a fence all around it and also plant grass inside. How much area does she need to plant? Find the cost of fencing it with barbed wire at the rate of ₹20 per metre leaving a space 3m wide for a gate on one side.

**Solution :** For finding area of the park, we have

$$2s = 50 \text{ m} + 80 \text{ m} + 120 \text{ m} = 250 \text{ m.}$$

i.e.,  $s = 125$  m

Now,  $s - a = (125 - 120)$  m = 5 m,

$s - b = (125 - 80)$  m = 45 m,

$s - c = (125 - 50)$  m = 75 m.

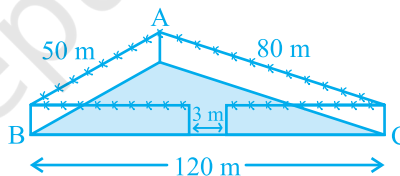

Fig. 12.7

$$\begin{aligned} \text{Therefore, area of the park} &= \sqrt{s(s-a)(s-b)(s-c)} \\ &= \sqrt{125 \times 5 \times 45 \times 75} \text{ m}^2 \\ &= 375\sqrt{15} \text{ m}^2 \end{aligned}$$

Also, perimeter of the park =  $AB + BC + CA = 250$  m

Therefore, length of the wire needed for fencing =  $250$  m  $- 3$  m (to be left for gate)  
= 247 m

And so the cost of fencing = ₹20  $\times$  247 = ₹4940

**Example 3 :** The sides of a triangular plot are in the ratio of 3 : 5 : 7 and its perimeter is 300 m. Find its area.

**Solution :** Suppose that the sides, in metres, are  $3x$ ,  $5x$  and  $7x$  (see Fig. 12.8).

Then, we know that  $3x + 5x + 7x = 300$  (perimeter of the triangle)

Therefore,  $15x = 300$ , which gives  $x = 20$ .

So the sides of the triangle are  $3 \times 20$  m,  $5 \times 20$  m and  $7 \times 20$  m

i.e., 60 m, 100 m and 140 m.

Can you now find the area [Using Heron's formula]?

$$\text{We have } s = \frac{60 + 100 + 140}{2} \text{ m} = 150 \text{ m,}$$

$$\begin{aligned} \text{and area will be } & \sqrt{150(150 - 60)(150 - 100)(150 - 140)} \text{ m}^2 \\ & = \sqrt{150 \times 90 \times 50 \times 10} \text{ m}^2 \\ & = 1500\sqrt{3} \text{ m}^2 \end{aligned}$$

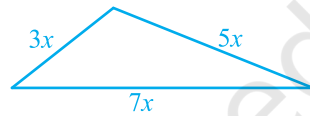

**Fig. 12.8**

### EXERCISE 12.1

1. A traffic signal board, indicating 'SCHOOL AHEAD', is an equilateral triangle with side ' $a$ '. Find the area of the signal board, using Heron's formula. If its perimeter is 180 cm, what will be the area of the signal board?
2. The triangular side walls of a flyover have been used for advertisements. The sides of the walls are 122 m, 22 m and 120 m (see Fig. 12.9). The advertisements yield an earning of ₹ 5000 per  $\text{m}^2$  per year. A company hired one of its walls for 3 months. How much rent did it pay?

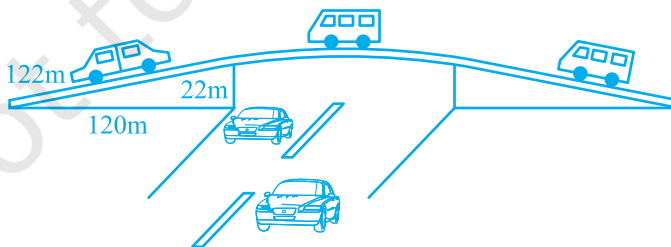

**Fig. 12.9**

3. There is a slide in a park. One of its side walls has been painted in some colour with a message "KEEP THE PARK GREEN AND CLEAN" (see Fig. 12.10). If the sides of the wall are 15 m, 11 m and 6 m, find the area painted in colour.

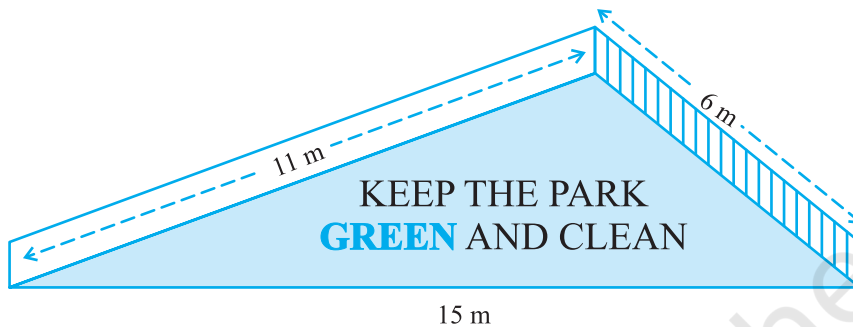

Fig. 12.10

4. Find the area of a triangle two sides of which are 18cm and 10cm and the perimeter is 42cm.
5. Sides of a triangle are in the ratio of 12 : 17 : 25 and its perimeter is 540cm. Find its area.
6. An isosceles triangle has perimeter 30 cm and each of the equal sides is 12 cm. Find the area of the triangle.

### 12.3 Application of Heron's Formula in Finding Areas of Quadrilaterals

Suppose that a farmer has a land to be cultivated and she employs some labourers for this purpose on the terms of wages calculated by area cultivated per square metre. How will she do this? Many a time, the fields are in the shape of quadrilaterals. We need to divide the quadrilateral in triangular parts and then use the formula for area of the triangle. Let us look at this problem:

**Example 4 :** Kamla has a triangular field with sides 240 m, 200 m, 360 m, where she grew wheat. In another triangular field with sides 240 m, 320 m, 400 m adjacent to the previous field, she wanted to grow potatoes and onions (see Fig. 12.11). She divided the field in two parts by joining the mid-point of the longest side to the opposite vertex and grew potatoes in one part and onions in the other part. How much area (in hectares) has been used for wheat, potatoes and onions? (1 hectare = 10000 m<sup>2</sup>)

**Solution :** Let ABC be the field where wheat is grown. Also let ACD be the field which has been divided in two parts by joining C to the mid-point E of AD. For the area of triangle ABC, we have

$$a = 200 \text{ m}, b = 240 \text{ m}, c = 360 \text{ m}$$

$$\text{Therefore, } s = \frac{200 + 240 + 360}{2} \text{ m} = 400 \text{ m.}$$

So, area for growing wheat

$$\begin{aligned}
 &= \sqrt{400(400 - 200)(400 - 240)(400 - 360)} \text{ m}^2 \\
 &= \sqrt{400 \times 200 \times 160 \times 40} \text{ m}^2 \\
 &= 16000\sqrt{2} \text{ m}^2 = 1.6 \times \sqrt{2} \text{ hectares} \\
 &= 2.26 \text{ hectares (nearly)}
 \end{aligned}$$

Let us now calculate the area of triangle ACD.

$$\text{Here, we have } s = \frac{240 + 320 + 400}{2} \text{ m} = 480 \text{ m.}$$

$$\begin{aligned}
 \text{So, area of } \triangle ACD &= \sqrt{480(480 - 240)(480 - 320)(480 - 400)} \text{ m}^2 \\
 &= \sqrt{480 \times 240 \times 160 \times 80} \text{ m}^2 = 38400 \text{ m}^2 = 3.84 \text{ hectares}
 \end{aligned}$$

We notice that the line segment joining the mid-point E of AD to C divides the triangle ACD in two parts equal in area. Can you give the reason for this? In fact, they have the bases AE and ED equal and, of course, they have the same height.

$$\begin{aligned}
 \text{Therefore, area for growing potatoes} &= \text{area for growing onions} \\
 &= (3.84 \div 2) \text{ hectares} = 1.92 \text{ hectares.}
 \end{aligned}$$

**Example 5 :** Students of a school staged a rally for cleanliness campaign. They walked through the lanes in two groups. One group walked through the lanes AB, BC and CA; while the other through AC, CD and DA (see Fig. 12.12). Then they cleaned the area enclosed within their lanes. If  $AB = 9 \text{ m}$ ,  $BC = 40 \text{ m}$ ,  $CD = 15 \text{ m}$ ,  $DA = 28 \text{ m}$  and  $\angle B = 90^\circ$ , which group cleaned more area and by how much? Find the total area cleaned by the students (neglecting the width of the lanes).

**Solution :** Since  $AB = 9 \text{ m}$  and  $BC = 40 \text{ m}$ ,  $\angle B = 90^\circ$ , we have:

$$\begin{aligned}
 AC &= \sqrt{9^2 + 40^2} \text{ m} \\
 &= \sqrt{81 + 1600} \text{ m} \\
 &= \sqrt{1681} \text{ m} = 41 \text{ m}
 \end{aligned}$$

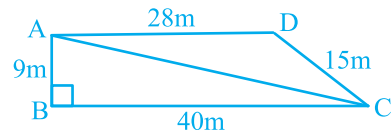

Fig. 12.12

Therefore, the first group has to clean the area of triangle ABC, which is right angled.

$$\begin{aligned}
 \text{Area of } \triangle ABC &= \frac{1}{2} \times \text{base} \times \text{height} \\
 &= \frac{1}{2} \times 40 \times 9 \text{ m}^2 = 180 \text{ m}^2
 \end{aligned}$$



The second group has to clean the area of triangle ACD, which is scalene having sides 41 m, 15 m and 28 m.

Here, 
$$s = \frac{41 + 15 + 28}{2} \text{ m} = 42 \text{ m}$$

Therefore, area of  $\Delta$  ACD = 
$$\begin{aligned} & \sqrt{s(s-a)(s-b)(s-c)} \\ &= \sqrt{42(42-41)(42-15)(42-28)} \text{ m}^2 \\ &= \sqrt{42 \times 1 \times 27 \times 14} \text{ m}^2 = 126 \text{ m}^2 \end{aligned}$$

So first group cleaned  $180 \text{ m}^2$  which is  $(180 - 126) \text{ m}^2$ , i.e.,  $54 \text{ m}^2$  more than the area cleaned by the second group.

Total area cleaned by all the students =  $(180 + 126) \text{ m}^2 = 306 \text{ m}^2$ .

**Example 6 :** Sanya has a piece of land which is in the shape of a rhombus (see Fig. 12.13). She wants her one daughter and one son to work on the land and produce different crops. She divided the land in two equal parts. If the perimeter of the land is 400 m and one of the diagonals is 160 m, how much area each of them will get for their crops?

**Solution :** Let ABCD be the field.

$$\text{Perimeter} = 400 \text{ m}$$

$$\text{So, each side} = 400 \text{ m} \div 4 = 100 \text{ m.}$$

$$\text{i.e. } AB = AD = 100 \text{ m.}$$

Let diagonal  $BD = 160 \text{ m}$ .

Then semi-perimeter  $s$  of  $\Delta$  ABD is given by

$$s = \frac{100 + 100 + 160}{2} \text{ m} = 180 \text{ m}$$

Therefore, area of  $\Delta$  ABD = 
$$\begin{aligned} & \sqrt{180(180-100)(180-100)(180-160)} \\ &= \sqrt{180 \times 80 \times 80 \times 20} \text{ m}^2 = 4800 \text{ m}^2 \end{aligned}$$

Therefore, each of them will get an area of  $4800 \text{ m}^2$ .

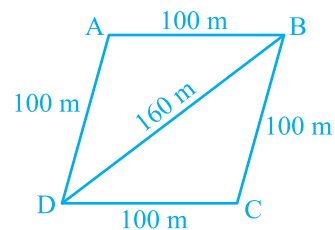

**Fig. 12.13**

**Alternative method :** Draw  $CE \perp BD$  (see Fig. 12.14).

As  $BD = 160$  m, we have

$$DE = 160 \text{ m} \div 2 = 80 \text{ m}$$

And,  $DE^2 + CE^2 = DC^2$ , which gives

$$CE = \sqrt{DC^2 - DE^2}$$

or,  $CE = \sqrt{100^2 - 80^2} \text{ m} = 60 \text{ m}$

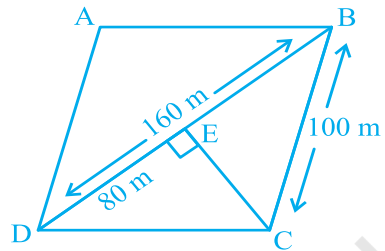

Fig. 12.14

Therefore, area of  $\Delta BCD = \frac{1}{2} \times 160 \times 60 \text{ m}^2 = 4800 \text{ m}^2$

### EXERCISE 12.2

1. A park, in the shape of a quadrilateral ABCD, has  $\angle C = 90^\circ$ ,  $AB = 9$  m,  $BC = 12$  m,  $CD = 5$  m and  $AD = 8$  m. How much area does it occupy?
2. Find the area of a quadrilateral ABCD in which  $AB = 3$  cm,  $BC = 4$  cm,  $CD = 4$  cm,  $DA = 5$  cm and  $AC = 5$  cm.
3. Radha made a picture of an aeroplane with coloured paper as shown in Fig 12.15. Find the total area of the paper used.

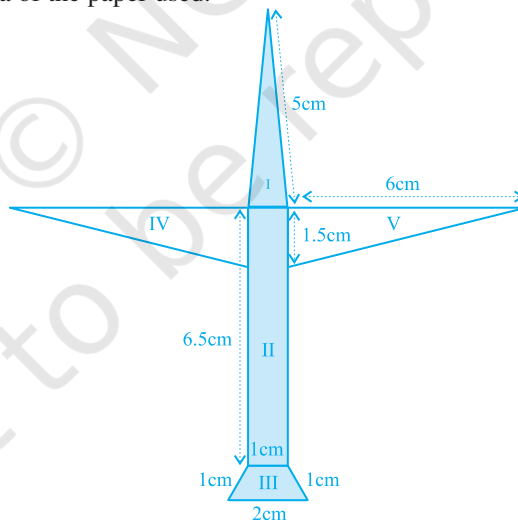

Fig. 12.15

4. A triangle and a parallelogram have the same base and the same area. If the sides of the triangle are 26 cm, 28 cm and 30 cm, and the parallelogram stands on the base 28 cm, find the height of the parallelogram.

- A rhombus shaped field has green grass for 18 cows to graze. If each side of the rhombus is 30 m and its longer diagonal is 48 m, how much area of grass field will each cow be getting?
- An umbrella is made by stitching 10 triangular pieces of cloth of two different colours (see Fig. 12.16), each piece measuring 20 cm, 50 cm and 50 cm. How much cloth of each colour is required for the umbrella?
- A kite in the shape of a square with a diagonal 32 cm and an isosceles triangle of base 8 cm and sides 6 cm each is to be made of three different shades as shown in Fig. 12.17. How much paper of each shade has been used in it?

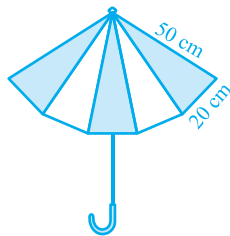

Fig. 12.16

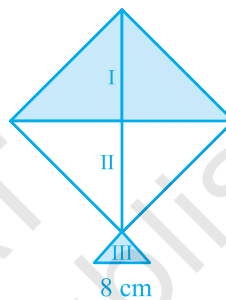

Fig. 12.17

- A floral design on a floor is made up of 16 tiles which are triangular, the sides of the triangle being 9 cm, 28 cm and 35 cm (see Fig. 12.18). Find the cost of polishing the tiles at the rate of 50p per  $\text{cm}^2$ .
- A field is in the shape of a trapezium whose parallel sides are 25 m and 10 m. The non-parallel sides are 14 m and 13 m. Find the area of the field.

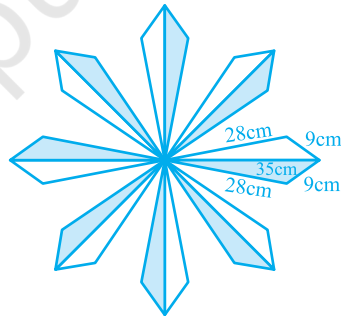

Fig. 12.18

## 12.4 Summary

In this chapter, you have studied the following points :

- Area of a triangle with its sides as  $a$ ,  $b$  and  $c$  is calculated by using Heron's formula, stated as

$$\text{Area of triangle} = \sqrt{s(s-a)(s-b)(s-c)}$$

where

$$s = \frac{a+b+c}{2}$$

- Area of a quadrilateral whose sides and one diagonal are given, can be calculated by dividing the quadrilateral into two triangles and using the Heron's formula.